



WARNING: Please take the time to read through the ENTIRE instructions prior to starting any work. Not following the instructions will invalidate the warranty.

Precautions

1. Light Pipe material is very sharp when cut. Please use extreme caution when handling the light pipe.
2. Light Pipe is very bright, use proper eye protection when installing. **AVOID LEAVING THE PIPE EXPOSED TO THE SUN WITHOUT THE PROTECTIVE COATING.** (Protective coating should only be removed in Step 13.)
3. Ensure normal safety precautions are taken when using tools and walking on roofs.
4. Do not cut any structural members in the house.
5. Ensure wire runs, plumbing or ventilation ducts will not interfere with the light pipe installation.
6. Measure twice and cut once.

Parts Lists

- A. Clear UV Protected, Acrylic Dome
- B. (4) Phillips Head Stainless Steel 1/2" Sheet Metal Screws
- C. (4) Dome Washers
- D. Black Nylon Horsehair Gasket (self adhesive backed)
- E. (6) Phillips Head Stainless Steel 1 1/2" Screws
- F. 1100 Series, Commercial Grade Aluminum Flashing
- G. Heavy Duty Foil Tape
- H. Light Pipe
- I. White Nylon Horsehair Gasket (self adhesive backed)
- J. (8) Tek Screws
- K. (3) Black Speed Nuts
- L. Ceiling Ring
- M. (3) 1 1/2" Phillips Screws
- N. (1) Large Clear Polycarbonate Lens
- O. Acrylic Soft White or Prismatic Diffuser
- P. White Powder Coated Aluminum Trim Ring
- Q. Caulk

Installation Pointers

- When determining location of the unit, southern exposure is recommended. Also consider potential problems such as objects shading the unit during certain times of the day.
- Although adjustable elbows are available for use, straight light pipe runs result in higher light output and easier installation. Prior to starting the job, cut packaging straps on the light pipe and uncoil the tubes.
- It is highly critical to check for obstructions above the ceiling which may hinder the installation. If possible, visually check to ensure that there are no electrical wires or other obstructions where you plan to install the skylight. If you can not check visually, use a piece of wire as outlined in Step 1.

Tools Needed

- Caulking Gun
- Drill
- Drywall Saw
- Flashlight
- Flat Bar
- Hammer
- Marking Pencil
- Measuring Tape
- Reciprocating Saw
- Safety Goggles
- Screwdriver
- Stud Finder
- String
- Tin Snips
- Utility Knife
- Wire

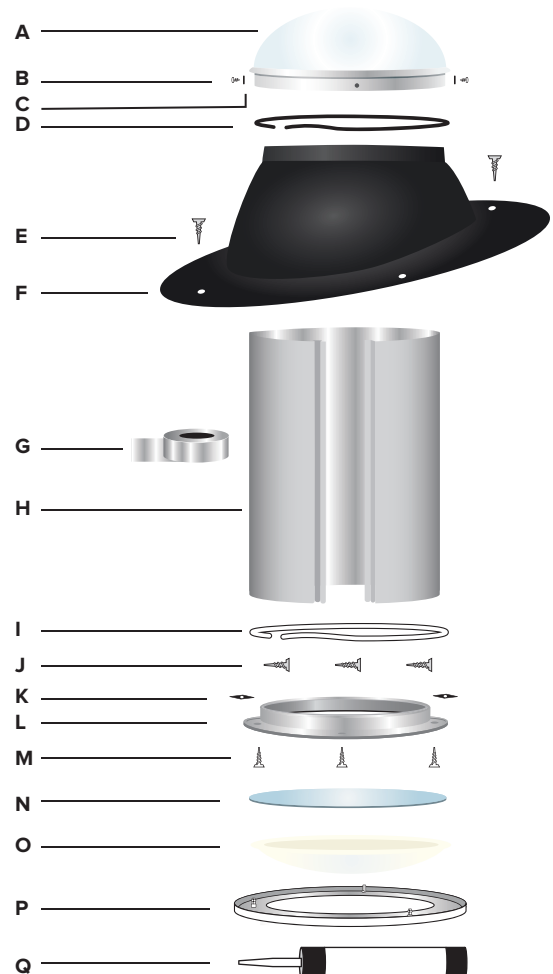

Optional:

*Angle Adapter
(not included)*



STEP 1 - To facilitate installation, once the desired location is obtained, ensure that there are no obstructions in the attic between the roof and ceiling or on the roof. With a stud finder, locate the ceiling joists and center the ceiling ring (K) between joists as close to the desired installation area as possible. Mark the center of the ceiling ring (K), drill a hole and insert a piece of wire bent at a 90 degree angle. Rotate the wire around 360 degrees. While rotating, feel for resistance that could indicate wire runs or other obstructions.

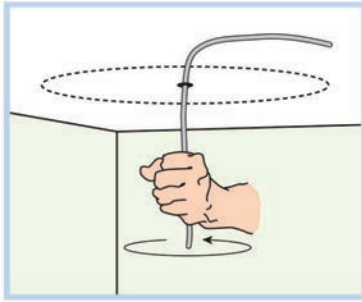

STEP 2 - If there are no obstructions, scribe a mark around the inside of the ceiling ring (K). Using a drywall saw, cut out the scribed mark in the ceiling.

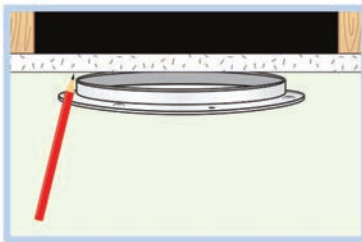

STEP 3 - Install the ceiling ring (K) on the ceiling. Place ceiling ring in the hole cut in Step 2. Peel the protective covering off the white horsehair gasket (H) and apply gasket to the inner lip of the ceiling ring (K). This gasket ensures a dust free fit between the light pipe and the ceiling collar. Secure the ceiling collar to ceiling by inserting a 1 1/2" Phillips flathead screw (L) into one of the three pre-drilled dimpled holes and inserting it up through the drywall into speed nut (J) provided. Repeat this process for the other two screws.

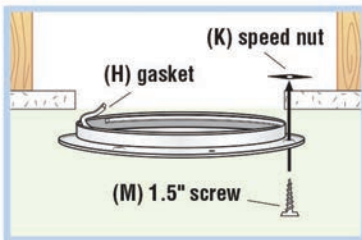

STEP 4 - Place a ladder under the ceiling ring hole and place a flashlight on top of the ladder. The resulting flashlight beam will mark the location for centering the hole. With a drill bit and appropriate extension rods, drill a pilot hole in the marked location on the bottom side of roof. If the attic is accessible, a plumb-bob may also be used.

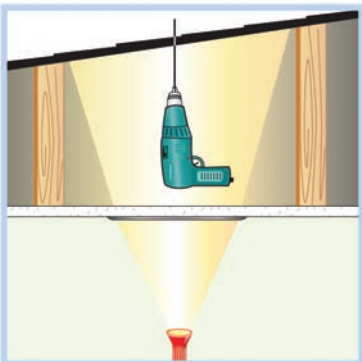

STEP 5 - On the roof, locate the centering hole and outline the diameter of the hole that the pipe will pass through by turning the flashing (E) upside down and marking the inside of the flashing unit.

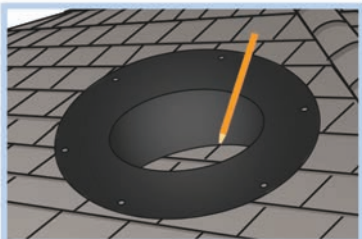

STEP 6 - IMPORTANT: Light pipe must pass between roof rafters. **DO NOT CUT THROUGH ANY FRAMING MEMBER.** With a reciprocating saw, cut the diameter of the hole 2" larger than the area marked in Step 5.

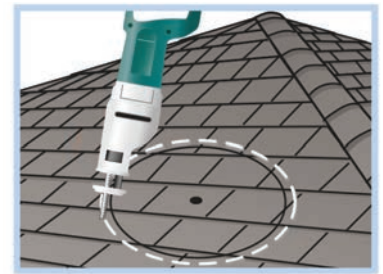

STEP 7 - With a utility knife, cut a four inch slit through the shingles and tar paper at the 3 and 9 o'clock positions of the flashing. This allows for the footprint of the flashing to be inserted under the shingles.

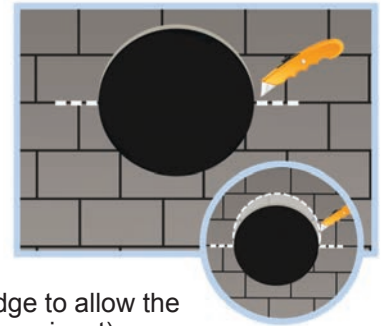

NOTE: Additional shingles may also need to be removed on the high side towards the ridge to allow the flashing to slide over the hole (see inset).

STEP 8 - Insert the reciprocating saw blade sideways at the 3 o'clock position and start cutting the roofing nails up and around to the 9 o'clock position. This process removes nails that prevent flashing foot print from sliding up underneath shingles.

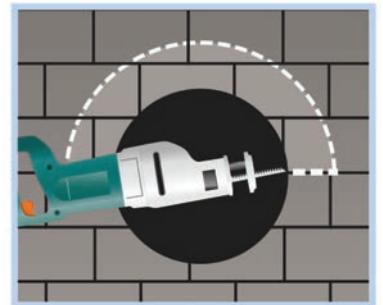

STEP 9 - Caulk the underside of the flashing (E) with the provided caulking material (P). Two concentric rings of caulking material is sufficient.



STEP 10 - Taking care not to smear caulk on the exposed shingles, slide the flashing under the tar paper and shingles and force flashing up until the shingles come in contact with the raised portion of the flashing. The bottom side of the flashing will be on top of the shingles. Secure flashing with six Phillips head screws (D).

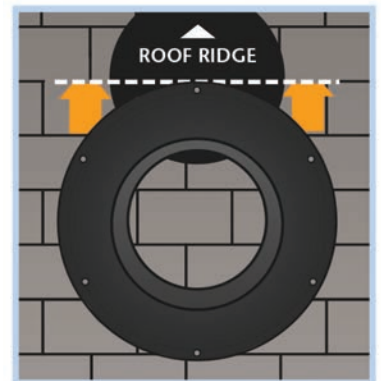

STEP 11 - Apply caulk over all exposed screw heads (since they will be exposed to the weather). Use remaining caulk to seal the areas where the 4" slits were made and around area where shingles meet with raised area of the flashing.

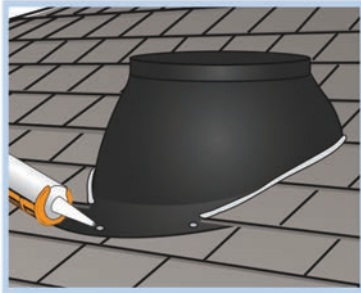

STEP 12 - Peel the protective backing off of the black horsehair gasket (C) and apply gasket on the inner lip of the flashing collar (E).

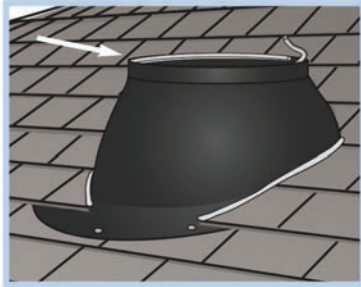

STEP 13 - Use a knife to score the protective film by cutting along the outside of the channel of the light pipe. Then peel off all of the protective plastic film from all areas of the light pipe.

NOTE: All of the plastic must be removed to avoid having the color of the plastic reflecting through the diffuser.

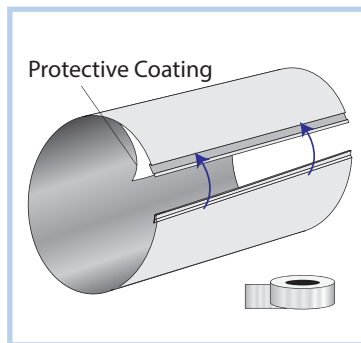

STEP 14 - To assemble the light tube, insert the light pipe into the channel so that it forms a round tube. After insertion, pull both sides back to ensure the pipe is locked into place.

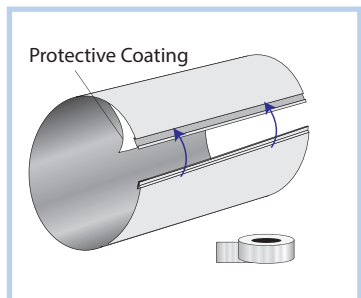

STEP 15 - When joining the two light pipe sections (G) together, with the crimped end down, place crimped end of one pipe into the non-crimped end of the other pipe. Secure with two tek screws (I) and seal joints with foil tape (F).

IMPORTANT: Remove protective coating that covers the mirror finish inside the tube.



STEP 16 - Insert light pipe (G) through the flashing unit (E) with crimped end down and gently rock pipe back and forth with slight downward pressure until pipe terminates evenly with the inner collar (K). Trim any excess light pipe with tin snips. Secure bottom of light pipe to ceiling ring with two tek screws (I).

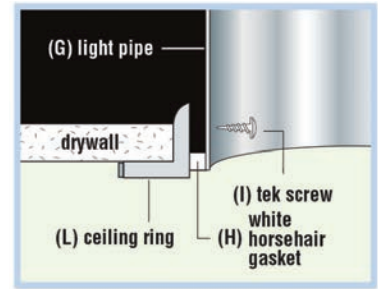

STEP 17 - If there is excess light pipe (G) sticking out of the flashing, using tin snips, cut from the top down to the lip of the flashing and trim off the excess pipe.

NOTE: Use caution, the light pipe is extremely sharp.

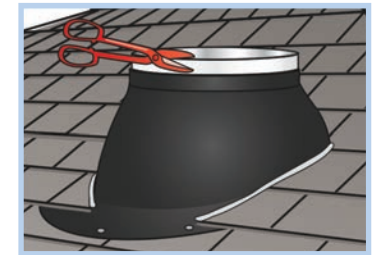

STEP 18 - Place dome (A) on top of the flashing unit (E). Secure the dome to the flashing by screwing (4) 1/4" sheet metal screws (B) through the pre-drilled holes on the dome collar and into the lip of the flashing.

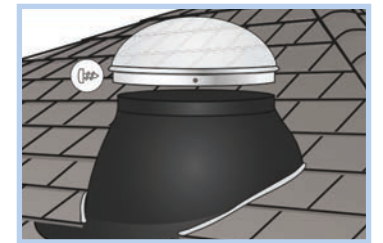

STEP 19 - Place the diffuser (N) into the white powder coated trim ring (O). Remove protective film from both sides of large lens (M) and place on top of diffuser (N).

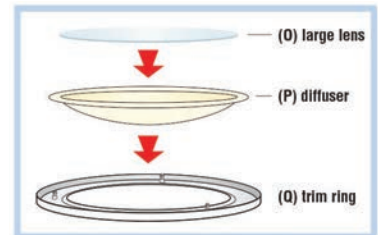

STEP 20 - Line up the three steel pins (four pins on 18" unit) of the white trim ring (O) with the holes on the ceiling ring (K). Push up to snap in place.

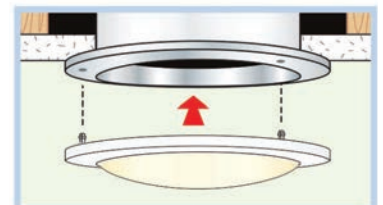



★ ★ ★ WARRANTY ★ ★ ★

This Natural Light Tubular Skylight has a 25-year warranty against manufacturing defects and deterioration.

IMPORTANT: PLEASE COMPLETE AND MAIL THE CARD BELOW AS SOON AS YOUR TUBULAR SKYLIGHT IS INSTALLED. This card will serve as proof of your purchase, should you misplace your original invoice.

The manufacturer warrants this product and its components to be free from defects in material and manufacturer's workmanship for a period of twenty five years from the date of installation. This warranty is subject to proper installation of the unit in accordance with the manufacturer's written installation instructions. The manufacturer will not be liable for any special, incidental, acts of god or consequential damages in any way related to, or arising out of, defects in, or damage to, the tubular skylight.

This warranty gives you specific legal rights, and you may have other rights which vary from state to state concerning exclusion or limitation of incidental or consequential damages.

*To register your product please fill out the form below and mail it to:
Natural Light Energy Systems • 10821 N 23rd Ave • Phoenix, AZ 85029*

★ ★ ★ REGISTRATION ★ ★ ★

Natural Light Tubular Skylight Installer: _____

Customer Name: _____ Date of Purchase: _____

Address: _____

City: _____ State: _____ Zip: _____

Phone: _____ Email: _____

Customer Survey

Are you satisfied with the performance? Y N

What made you choose our product? _____

Were you satisfied with the installation job? Y N