

13" Warehouse Installation



10821 North 23rd Avenue
Phoenix, AZ 85029
800-363-9865
www.nltubular.com

IMPORTANT: Please take the time to read through the ENTIRE instructions prior to starting any work. Light Pipe material is very sharp when cut. Please use extreme caution when handling the light pipe. AVOID LEAVING THE PIPE EXPOSED TO THE SUN WITHOUT THE PROTECTIVE COATING OR DIFFUSERS IN PLACE PRIOR TO INSTALLATION.

PARTS LIST

1. Clear UV Protected, High Impact Acrylic Dome
2. (4) Phillips Head Stainless Steel 1/4" Self-Tapping Screws
3. Black Nylon Horse Hair Gasket (self-adhesive)
4. (4) 1 1/2" Flathead Phillips Screws
5. 1100 Series Aluminum Flashing
6. (6) Phillips Head Stainless Steel 1 1/2" Screws
7. Heavy Duty Foil Tape
8. Light Pipe
9. (4) Phillips Head Stainless Steel 1/2" Sheet Metal Screws
10. White Nylon Horse Hair Gasket (self-adhesive)
11. High Impact Acrylic Prismatic Diffuser
12. (4) Phillips Head Stainless Steel 1/2" Sheet Metal Screws
13. White Powder Coated Warehouse Trim Ring

close-up
of screws:

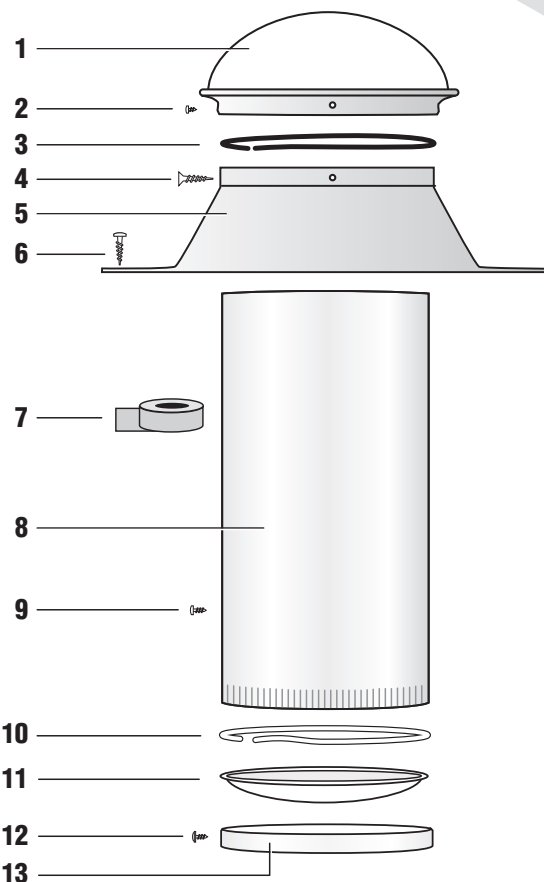
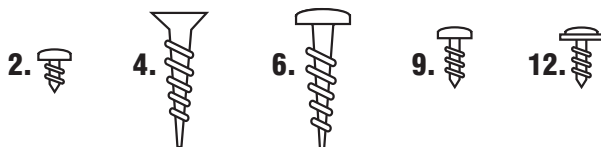

TOOLS NEEDED

- Reciprocating Saw
- Measuring Tape
- Driver & Bits
- Phillips Screwdriver
- Clamp
- Caulking Gun
- Stud Finder
- Marking Pencil
- Tin Snips

Step 1

From the warehouse roof, find the desired location to install the 13" unit. Ensure that there are no obstructions (wiring, framing, etc.) to hinder the installation. Outline the diameter of the hole that the pipe will pass through by turning the flashing upside down and marking the inside of the flashing unit.

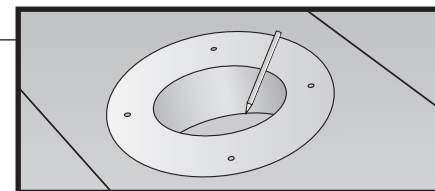

Step 2

With a reciprocating saw, cut the diameter of the hole 1" larger than the area marked in Step 1. **IMPORTANT:** The light pipe must pass between the roof rafters. DO NOT CUT THROUGH ANY FRAMING MEMBER.

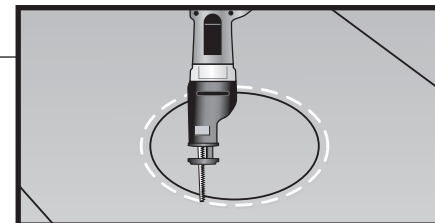

Step 3

Caulk underside of flashing with the provided caulking material. Two concentric rings of caulking material is sufficient. Turn flashing right-side-up and center over hole cut in Step 2. Press firmly down on flashing until caulk slightly squeezes out at the lip of the flashing.

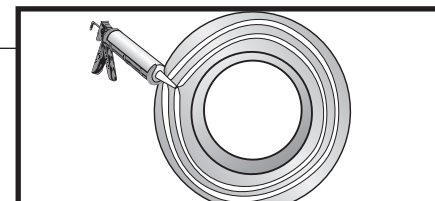

Step 4

Secure flashing with (6) Phillips head 1 1/2" screws (part #6) provided. Evenly space the screws around the lip of the flashing. Place first screw at the 12:00 o'clock position, then next diagonally over from it at 6:00. The third screw should go at 9:00 and the next screw diagonally across at 3:00, etc. Caulk over the screw heads, since it will be exposed to the weather.

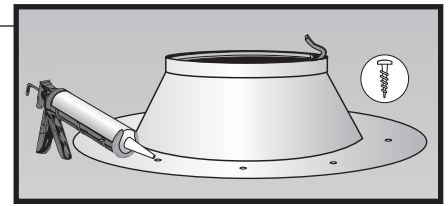

Step 5

To assemble light pipe, peel back the protective coating that covers the mirror coating about 1" from the opposite edge of the double sided tape, remove paper cover over double sided tape and overlap and seal edges. Put pressure on both sides of seal to ensure a good bond. Secure tube using the (2) 1/2" sheet metal screws (part #9) provided. Then place foil tape over the entire seam to strengthen seal. When joining two pipe sections together, place crimped end into the next section of pipe. Secure with a 1/2" sheet metal screws (part #9) provided and seal joints with foil tape.

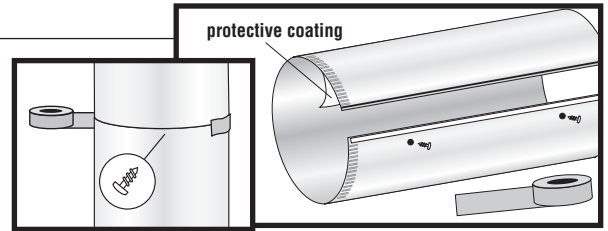

Step 6

Place light diffuser inside of the warehouse trim ring. Peel the protective backing off the white nylon horse hair gasket and apply gasket on the **INSIDE OF THE TRIM RING** just above the diffuser. Place gasket as close to diffuser as possible.

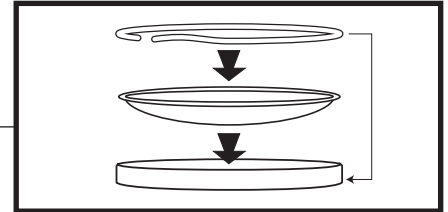

Step 7

Slide the trim ring assembly over the crimped edge of the light pipe until it is snug. Secure the trim ring to the light pipe using the (4) Phillips head 1/2" screws (part #12) provided.

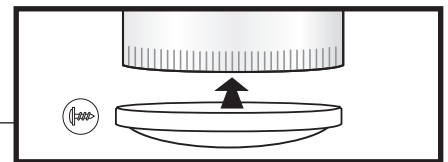

Step 8

Slide light pipe (with trim ring facing down) through the opening on the flashing. Secure the light pipe to the flashing with the (4) Phillips flathead 1 1/2" screws (part #4) provided through the (4) pre-drilled holes on the flashing lip. (To prevent light pipe from slipping through the hole, clamp light pipe to flashing or have someone hold it in place until it is secured.) If there is excess pipe sticking out of the flashing, using tin snips, cut from the top down to the lip of the flashing and trim off the excess pipe.

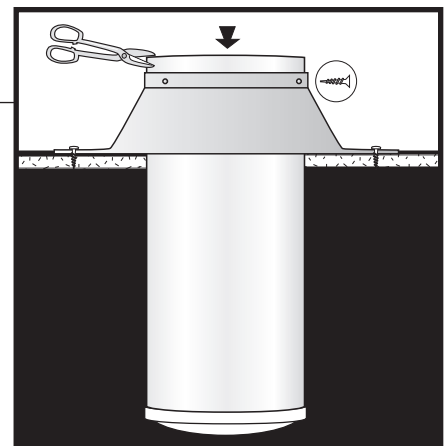

Step 9

Place dome on top of the flashing unit. Secure dome to flashing by screwing in the (4) self-tapping Phillips head 1/4" screws (part #2) provided into the pre-drilled holes in the dome collar.

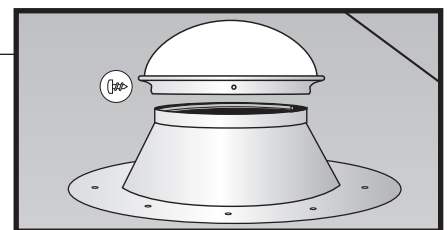

Please fill out the form and mail it to: Natural Light Energy Systems • 10821 North 23rd Avenue • Phoenix, AZ 85029

REGISTRATION

Installer Name: _____ Date of Purchase: _____

Customer Name: _____ Phone: _____

Address: _____ City: _____ State: _____ Zip: _____

Customer Survey

Are you satisfied with the performance? Y N Were you satisfied with the installation job? Y N

What made you choose our product? _____